

**public guidance &  
information systems**



# About Via Guide



Public guidance systems of Via Guide GmbH stand for very high quality under the seal of „MADE IN GERMANY“.

The company, located in Arnsberg, Germany, is characterized by special expertise within the field of barrier systems, enhanced through its partnership with the American enterprise Lavi Industries.

Well-engineered, superior quality products are evident through aesthetics and functionality. We have our own engineering and production departments which allow for fully developed solutions, earning us the title of an industry leader.

Our public guidance systems are distinguished by superior quality and guaranteed durability. Flexible layouts are achieved by selecting from the extensive product range.

Choose between Beltrac posts with belts, traditional posts with ropes, and many other complementary accessories.

**MADE IN  
GERMANY**



Time	Flight	Destination	Gate	Status
10:10	HE 814/7	DRESDEN / LEIPZIG	02	BOARDING
16:20	HE 914	MURNBERG	02	
10:40	HE 814	STUTTGART	03	
17:20	HE 516	BERLIN THF	02	
17:25	LH 1217	MUNICH	28-30	DELAYED
18:05	EZY4983	KRAKAU	16-20	
18:25	EZY4957	LONDON LTN	16-20	
18:45	EZY4989	PARIS	16-20	



# Product's View

## Beltrac®

The Concept	06 - 07
Classic	08
Extend	09
Modern	10
Infinity	11
Magnetic	12
Double Belt	13
Basic	14
Expo	15
Safety	16
Outdoor	17
StoreTrac Double	18
StoreTrac Mono/Mini	19
Wall Mount	20 - 22
ShuttleTrac™	23
JetTrac™	24 - 25
Qtrac™	26 - 27
Signage and Accessories	28 - 29
Belt Imprinting	30
NeXtrac®	31 - 33
Replacement Parts	34



**Classic** pg. 08  
**Extend** pg. 09



**Modern** pg. 10  
**Infinity** pg. 11



**Magnetic** pg. 12



**Double Belt** pg. 13



**Wall Mount** pg. 20/22  
» Wall mounted belt mechanisms



**ShuttleTrac™** pg. 23  
» Post transporter



**JetTrac™** pg. 24/25  
» Airport trolley

## Traditional

Luxor	36
Prado	37
Metropolis	38
Ambassador	39
Crown	40
Museum	41
Ropes and Accessories	42 - 43



**Luxor**  
pg. 36



**Prado**  
pg. 37



**Metropolis**  
pg. 38

Time	Flight	Destination	Gate	Status
10:10	HE 814/7	DRESDEN / LEIPZIG	02	
16:20	HE 914	MUNBERG	02	
18:40	HE 814	STUTTGART	03	
17:20	HE 518	BERLIN THF	02	
17:25	LH 1217	MUNCHEN	28-30	
18:05	EZY4983	KRAKAU	16-20	DELAYED
18:25	EZY4957	LONDON LTN	16-20	
18:45	EZY4989	PARIS	16-20	



**Basic** pg. 14



**Expo** pg. 15



**Safety** pg. 16



**Outdoor** pg. 17



**StoreTrac** pg. 18/19



**Qtraq™** pg. 26/27  
» Electronic Queuing



**Signage and Accessories** pg. 28/29



**NeXtrac®** pg. 31/33  
» Shop-System



**Ambassador**  
pg. 39



**Crown**  
pg. 40



**Museum**  
pg. 41



**Ropes and Accessories**  
pg. 42/43

# Beltrac® The Concept

MADE IN GERMANY

## Function and Manufacturing

### Beltrac® Mechanism.

Beltrac posts are equipped with a self-retracting belt mechanism.

- >> Slow belt retraction thanks to our centrifugal belt-braking system
- >> Safe belt guide, internally placed
- >> Tightly woven belt, maintains shape



### Assembly.

The tube connects to the cast iron base with deep positive contact threading.

- >> Quick and easy assembly
- >> Great stability
- >> Rigid cast iron base with 350 mm diameter



**!** Subject to change without notice.

## Belt Colour Range

Beltrac offers a wide range of belt colours and patterns: From classic to modern or fluorescent colours.

Grey, Black, Blue, Navy, Dark Blue, Green, Olive, Brown, Burgundy, Red, Orange, Neon Yellow, Red/White, Black/Yellow diagonally

- >> Belt samples are available upon request.



**!** Typographically caused colour variations possible.

## Mounting Options

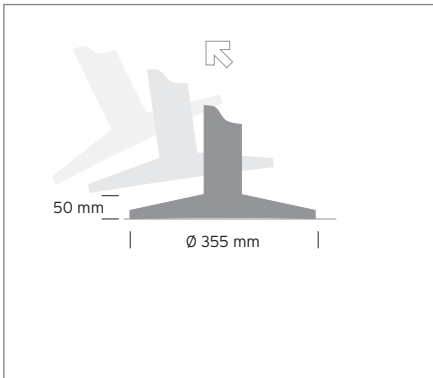

### 1 >> The Mobile Post

Flexible, easy to install, multi-directional. Each post includes a standard rubberized base to protect flooring from damage.

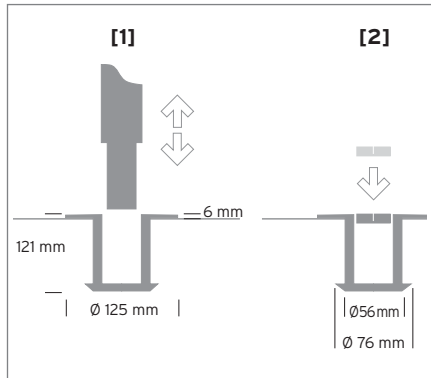
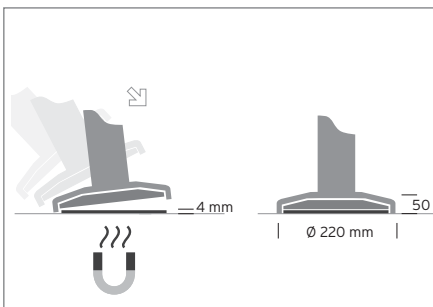

### 2 >> The Removable Post

Can be easily inserted into the floor mounting [1]. When the post is not in use, a cover plate conceals the hole in the floor [2].

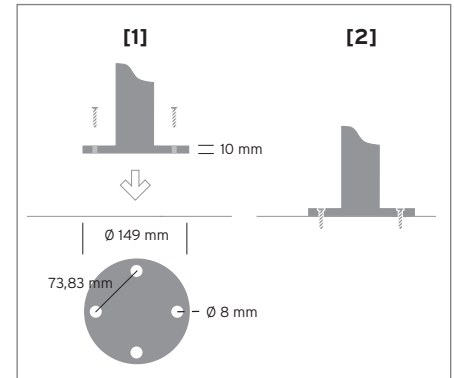

### 3 >> The Permanently Mounted Post

The post base plate is mounted with screws directly to the floor [2].

### 4 >> The Magnetic Post

The provided base plate is fixed to the floor with a central screw or a special, two-sided adhesive foil. The post can be mounted or dismantled easily - without any further set-up (see also page 12).

## Belt Receivers

Every post is equipped with a standard 4-way post connection (1 start, 3 receivers) which allows many positioning possibilities. With a wall receptacle on the opposite side, belts can also be fastened to a wall.

The belts are easily inserted into the receivers. To prevent unauthorized opening and closing, Beltloc automatic belt locking is available as an option (please see the chapter Replacement Parts).

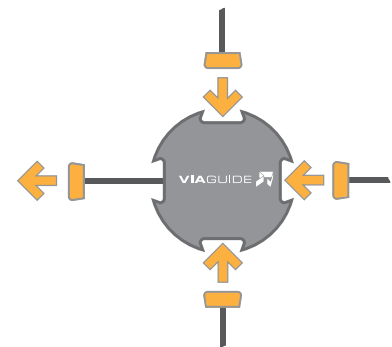

## Belt Imprinting

Our in-house digital imprinting production can customise your Beltrac® belts with logos, messages and colour photos. In addition to our standard belt width of 5 cm, Beltrac Classic and Beltrac Wall

Mount M are also available with a 10 cm belt width / 2 m belt length as an option. An ideal advertisement space for your messages! (Please see page 30.)



# Beltrac® Classic



## Classic - Our Best Seller

- >> 2,3 meter belt length
- >> 4 longitudinal dovetail grooves on aluminium tube
- >> Potential to receive 3 belts and accessories

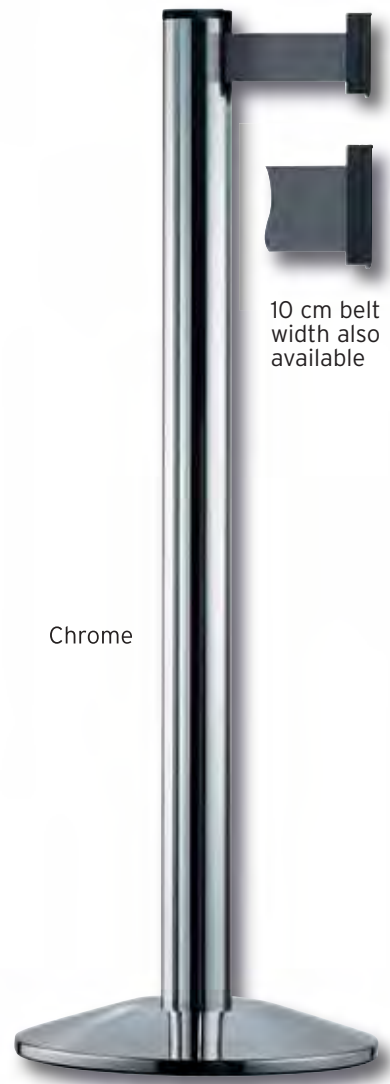

10 cm belt width also available

Chrome

## Technical Data

	Total Weight	approx. 12 kg
	Base Weight	approx. 9 kg
<b>Tube Style:</b> 	Material	Aluminium
	4-Way Belt Connection	yes
	Rubberised Base	yes
	Beltloc	optional
	Belt End Safety Lock	optional
	Signage	optional
	Outdoor Usage	optional

For belt colours and mounting options please refer to Beltrac - The System (page .06f)





**Extend - The Lengthened Belt Design**

- >> 3,7 meter belt length
- >> 4 longitudinal dovetail grooves on aluminium tube
- >> Potential for 3 arriving belts and accessories



Chrome

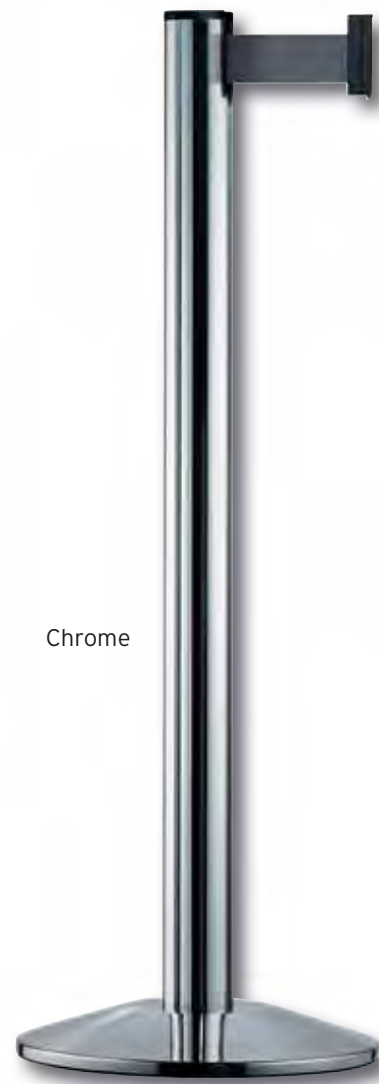

**Technical Data**

	Total Weight	approx. 13 kg
	Base Weight	approx. 9 kg
<b>Tube Style:</b> 	Material	Aluminium
	4-Way Belt Connection	yes
	Rubberised Base	yes
	Beltloc	optional
	Belt End Safety Lock	optional
	Signage	optional
	Outdoor Usage	optional

For belt colours and mounting options please refer to Beltrac - The System (page .06f)



**Modern - Sleek Round Tube**

- >> 2,3 meter belt length
- >> Post with 3 plastic belt receivers
- >> Potential for 3 arriving belts



Polished Stainless Steel    Brushed Stainless Steel

Brass    Chrome

Black

**Technical Data**

	Total Weight	approx. 12 kg
	Base Weight	approx. 9 kg
	Material	Steel, Stainless Steel
	4-Way Belt Connection	yes
	Rubberised Base	yes
	Beltloc	optional
	Belt End Safety Lock	optional
	Signage	optional
	Outdoor Usage	optional

For belt colours and mounting options please refer to Beltrac - The System (page .06f)

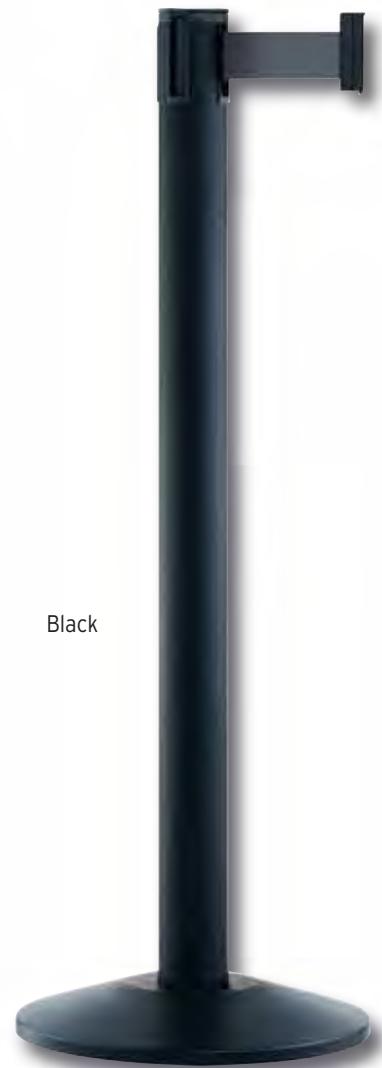



**Infinity - Distinguished Design**

- >> 3,7 meter belt length
- >> Post with 3 plastic belt receivers
- >> Potential for 3 arriving belts



Polished  
Stainless Steel

Black

**Technical Data**

	Total Weight	approx. 13 kg
	Base Weight	approx. 9 kg
	Material	Steel, Stainless Steel
	4-Way Belt Connection	yes
	Rubberised Base	yes
	Beltloc	optional
	Belt End Safety Lock	optional
	Signage	optional
	Outdoor Usage	yes

For belt colours and mounting options please refer to Beltrac - The System (page .06f)



Brushed  
Stainless  
Steel

# Beltrac® Magnetic



## Magnetic - The Flexible Mounting Solution

- >> High stability magnetic base
- >> Attaches to stainless steel floor plate
- >> Post releases under force of 18 kg (peel force at the top)

The stainless steel plate can be mounted to the ground with screws or with a special adhesive allowing for easy and low cost installation.

Magnetic option available for Classic, Extend, Modern, and Infinity. Post colours determined by post style (please refer to the corresponding model descriptions).

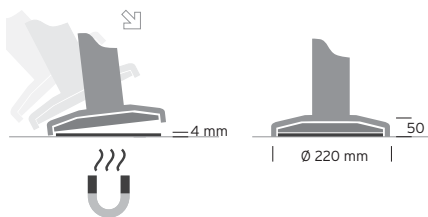

## Technical Data

	Total Weight	approx. 11 kg
	Magnetic Base	215 mm
	Material	Aluminium, Steel, Stainless Steel
	4-Way Belt Connection	yes
	Beltloc	optional
	Belt End Safety Lock	optional
	Signage	optional
	Outdoor Usage	optional

For belt colours please refer to Beltrac - The System (page .06f)



Brushed  
Stainless  
Steel

# Beltrac® Double Belt



**Double Belt - Twice the Guidance**

- >> 2 x 2,3 meter belt lengths
- >> 4 longitudinal dovetail grooves on aluminium tube
- >> Potential for 6 arriving belts

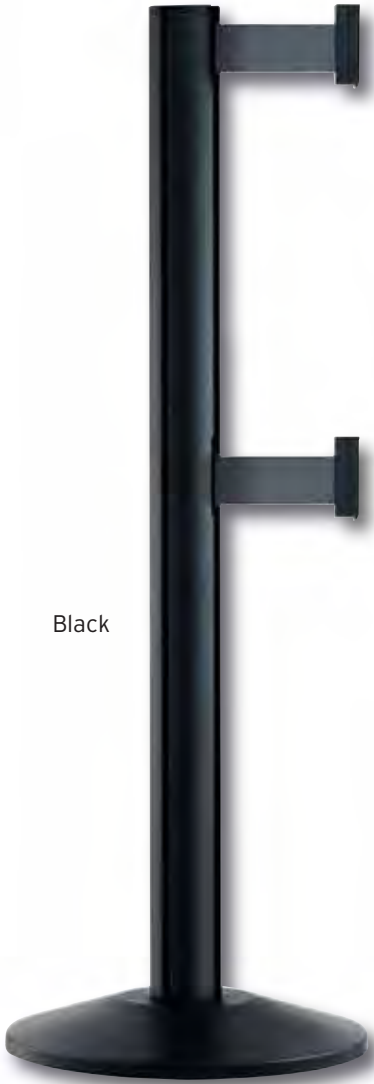

**Technical Data**

	Total Weight	approx. 12 kg
	Base Weight	approx. 9 kg
	Material	Aluminium
	4-Way Belt Connection	yes
	Rubberised Base	yes
	Beltloc	optional
	Belt End Safety Lock	optional
	Signage	optional
	Outdoor Usage	optional

For belt colours and mounting options please refer to Beltrac - The System (page .06f)

# Beltrac® Basic



## Basic - The Simple Solution

- >> 2 meter belt length
- >> Potential for 3 arriving belts
- >> Available only for mobile installation



### Belt colours:

Black, Red and Blue

### Technical Data

	Total Weight	approx. 12 kg
	Base Weight	approx. 9 kg
	Material	Steel
	4-Way Belt Connection	yes
	Rubberised Base	yes
	Belt End Safety Lock	optional

Black

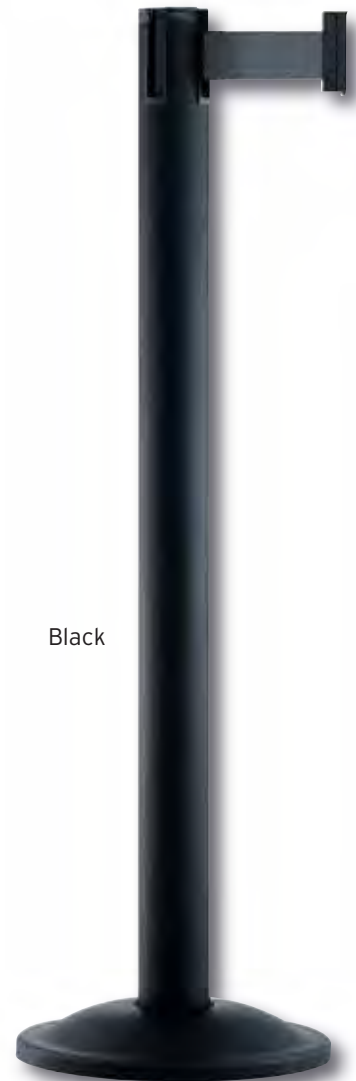



**Expo - The Exhibition Solution**

- >> 2,3 meter belt length
- >> Potential for 3 arriving belts
- >> Low post height does not obstruct view of exhibits



Grey

Black

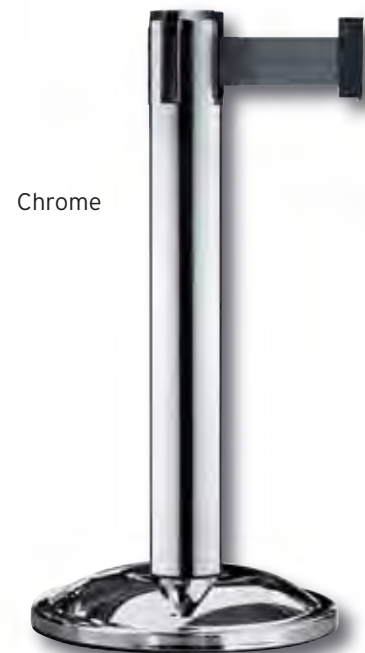

Chrome

**Technical Data**

	Total Weight	approx. 12 kg
	Base Weight	approx. 8 kg
	Material	Steel
	4-Way Belt Connection	yes
	Rubberised Base	yes
	Beltloc	optional
	Belt End Safety Lock	optional
	Signage	optional
	Outdoor Usage	optional

For belt colours and mounting options please refer to Beltrac - The System (page .06f)



**Safety - For Safety in Production and Storage Areas**

- >> Safety Classic - 2,3 meter belt length, Safety Extend - 3,7 meter belt length, Safety Double - 2 x 2,3 meter or 2 x 3,7 meter belt lengths
- >> 4 longitudinal dovetail grooves on aluminium tube
- >> Potential for 3 arriving belts for Safety Classic and Extend or 6 arriving belts for Safety Double



Red

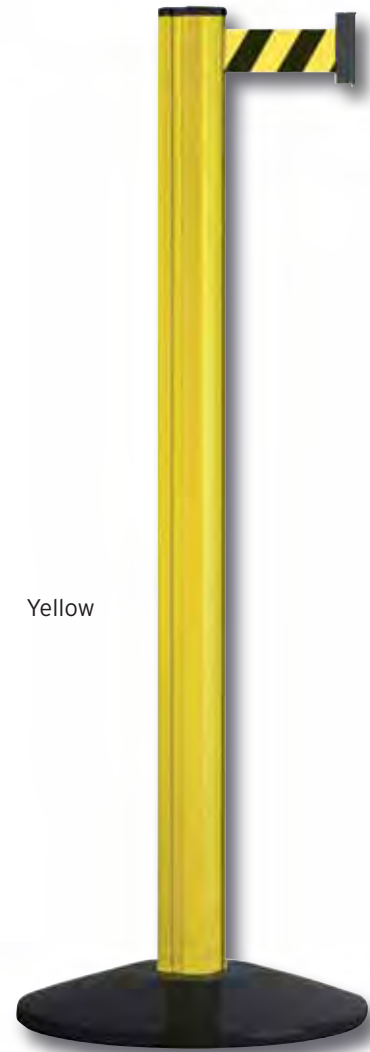

Yellow

**Technical Data**

	Classic / Extend	
	Total Weight	approx. 12 kg/ approx. 13 kg
	Base Weight	approx. 9 kg
	Material	Aluminium
	4-Way Belt Connection	yes
	Rubberised Base	yes
	Beltloc	optional
	Belt End Safety Lock	optional
	Signage	optional
	Outdoor Usage	optional

Belt Colors: Safety Red/White, Safety Black/Yellow, Plastic cover plate: Black





## Outdoor - Specifically for Use Outside

- >> 3,7 meter belt length
- >> Potential for 1 arriving belt
- >> Hollow base to be filled with water (5,5 litres), sand or concrete  
Alternative: solid rubber base
- >> Base colour offered in black



Orange

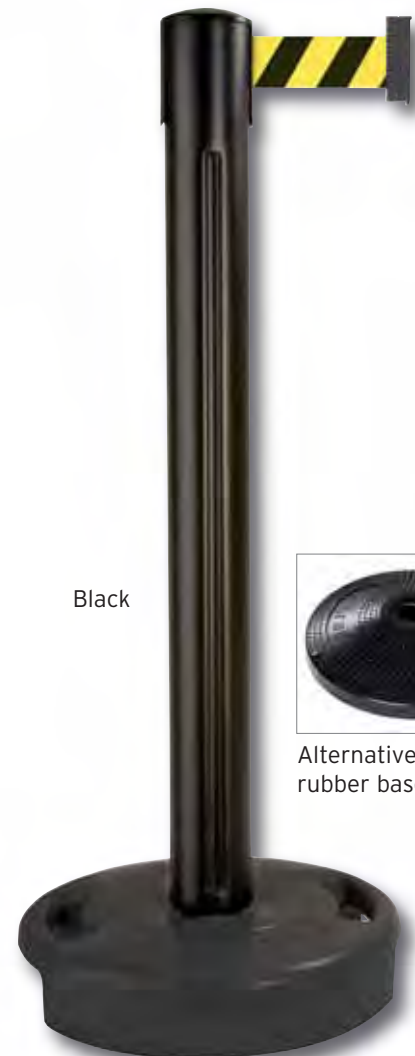

Black



Alternative: solid rubber base

## Technical Data

<p>970 mm</p> <p>∅ 380 mm</p> <p>∅ 90 mm</p> <p>&gt; 3700 mm</p> <p>Tube Style:</p>	Total Weight	approx. 8 kg
	Base Weight (rubber)	approx. 7kg
	Material	PVC
	4-Way Belt Connection	no
	Rubberised Base	no
	Beltloc	no
	Belt End Safety Lock	optional
	Signage	no
	Outdoor Usage	yes

For belt colours please refer to Beltrac - The System (page .06f)

# StoreTrac Double



**With the StoreTrac Double it is possible to block off potentially dangerous or large areas quickly and easily.**

- >> Sturdy aluminium or stainless steel construction
- >> Easy handling: Low centre of gravity and self-contained easy moving wheels
- >> 20 meter belt length with integrated centrifugal brake to control belt if accidentally released
- >> Mechanism swivels allowing belts to extend in any direction, reducing belt abrasion
- >> Replacement parts available for easy maintenance



## Technical Data

	Total Weight	approx. 55 kg
	Overall Height	approx. 1006 mm
	Base Width	approx. 562 mm
	Belt Length	1 x 20 m or 2 x 20 m
	Belt Colours	Neon Yellow, Black, Blue
	Wall Receptacle	optional

# StoreTrac Mono / Mini



## Convenient barrier system ideal for a wide range of applications

- >> Sturdy aluminium construction
- >> 9 meter belt length complete with centrifugal brake to control belt if accidentally released
- >> Suitable for indoor or outdoor usage

### Technical Data StoreTrac Mono

	Total Weight	approx. 22 kg
	Overall Height	approx. 1000 mm
<b>Tube Style:</b> 	Belt Length	9 m
	Belt Colors	Neon Yellow, Black, Blue
	Wall Receptacle	optional
	Finish	Satin

### Technical Data StoreTrac Mini

	Total Weight	approx. 14 kg
	Overall Height	approx. 600 mm
<b>Tube Style:</b> 	Belt Length	9 m
	Belt Colours	Neon Yellow, Black, Blue
	Wall Receptacle	optional
	Finish	Red
	Handle	optional



# Beltrac® Wall Mount



## Wall Mount - The Wall Solution

- >> Wall mechanism complete with mounting bracket
- >> Belt lengths available in 2,3 m / 3,7 m / 5,4 m



**Wall Mount M:**  
2,3 m belt length



**Wall Mount M:**  
2,3 m belt length  
10 cm belt width



**Wall Mount L:**  
3,7 m belt length

## Wall Mount M / L (Magnetic)

Wall Mount M / L (2,3 m or 3,7 m belt lengths) are additionally available with magnetic accessories. The attachment plate and belt end are equipped with magnets allowing for easy attachment to metallic surfaces.



## Casing Finishes

All Beltrac Wall Mount casings come standard with a black finish. Wall Mount M / L are also available in satin or chrome finishes.

## Technical Data

Wall Mount M	Wall Mount L	Back-Plate	Total Weight (M)	approx. 0,5 kg
∅ 70 mm	∅ 83 mm	← 38 mm →	Total Weight (L/XL)	approx. 0,7 kg
			Material	Aluminium
			2-Way Belt Connection	yes
			Beltloc	optional
			Belt End Safety Lock	optional
			Signage	optional
			Outdoor Usage	optional
			Wall Receptacle	optional

For belt colours please refer to Beltrac - The System (page .06f)

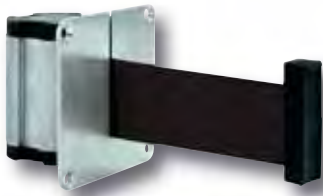

**Wall Mount M / L (Recessed)**  
2,3 m / 3,7 m belt length

The Wall Mount M / L (2,3 m or 3,7 m belt lengths) are also available as recessed units. The wall mount is equipped with a front plate that sits flush to wall allowing for the mechanism to be concealed. This unit is available in a satin finish.

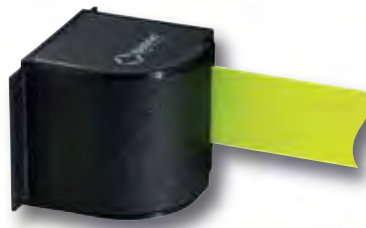
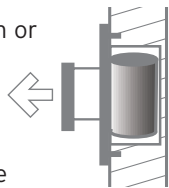

**Wall Mount XL:**  
5,4 m belt length



**Quick Mount**

The Wall Mount XL (5,4 m belt length) is also available with a Velcro accessory designed for temporary attachment, ideal for shelving units.

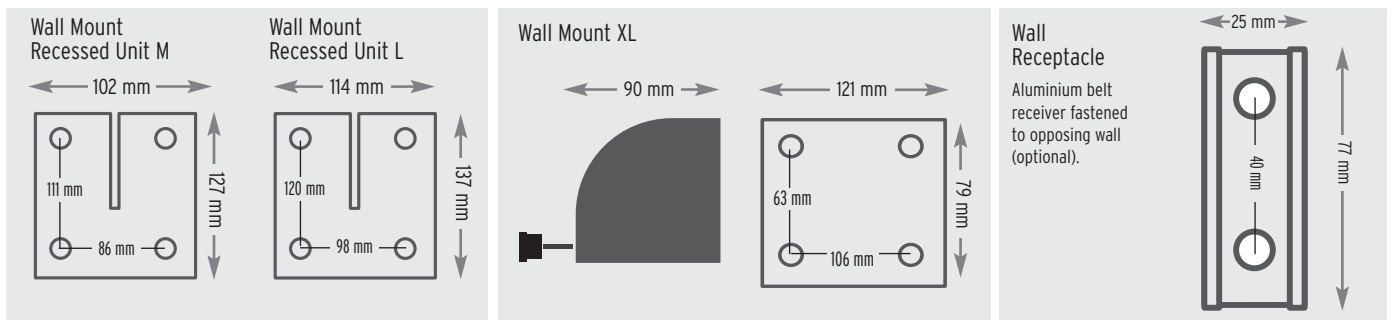

For belt colours please refer to Beltrac - The System (page .06f)

# Beltrac® Wall Mount



## Wall Mount XXL

- >> 10 m, 20 m belt lengths
- >> Flexible mechanism mounting
- >> Suitable for outdoor use
- >> Rotating mechanism: easily adapts to any direction limiting belt abrasion
- >> Integrated centrifugal break to control belt if accidentally released



**Wall Mount XXL:**  
10 m / 20 m belt length

## Technical Data

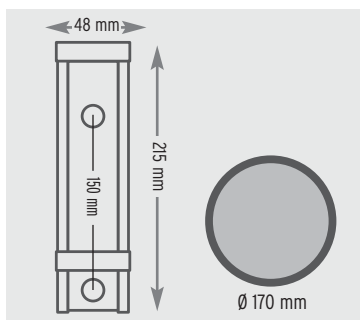

**Wall Receptacle**  
Aluminium belt receiver fastened to opposing wall (optional).

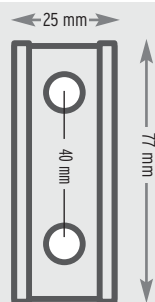

Total Weight (XXL)	approx. 4 kg
Material	Aluminium
Beltloc	no
Belt End Safety Lock	optional
Signage	optional
Outdoor Usage	optional
Belt Colors 10 m	See Beltrac - the System pg. 6
Belt Colors 20 m	Neon Yellow, Black, Blue
Finishes	Black, Silver
Wall Receptacle	optional



## ShuttleTrac™

The ShuttleTrac™ is the ideal solution for the transport and storage of posts. It facilitates and supports your staff by aiding in the quick deployment or removal of posts from any area.

- >> Transport of up to 9 posts per ShuttleTrac™
- >> Connect several ShuttleTracs™ together for maximum post transport
- >> Easy handling of several ShuttleTracs™ by 1 person
- >> Low overall height allows for easy loading and unloading of posts
- >> Optional electric pull motor
- >> Easy storage even in tight places
- >> Quick assembly
- >> Durable construction

## Technical Data

	Total Length	approx. 1050 mm
	Total Width	approx. 813 mm
	Total Weight	approx. 28,5 kg
	Material	HDPE
	Outdoor Usage	yes
	Pull Handle	comes standard
	Electric Pull Motor	optional





**The JetTrac™ clearly defines safe areas for passengers during boarding as well as quickly closes off dangerous areas.**

- >> Highly durable system from aluminium and stainless steel
- >> Easy handling due to a low centre of gravity and self-contained, easy moving wheels
- >> 20 meter belt system including a centrifugal brake: If accidentally released, the brake will activate
- >> Swivelling belt mechanism which adjusts to any direction of pull reducing belt abrasion
- >> Easy to maintain with replacement components
- >> The tube features three longitudinal dovetail grooves, which can be used to receive different accessories (e.g. chock storage, light wands)



**Technical Data**

	<p><b>Rohrform:</b></p>	Total Weight	approx. 55 kg
		Total Height	approx. 1006 mm
		Width Above	approx. 562 mm
		Base Width	approx. 595 mm
		Belt Length	1 x 20 m / 2 x 20 m
		Belt Colors	Neon Yellow, Black, Blue





Thanks to the large self-contained wheels, JetTrac™ is quick and easy to manoeuvre.



The belt end options are a hook or belt clip allowing for quick attachment or detachment.



Durable and weather-resistant belt mechanism.

# Qtrac™ Electronic Queuing



## Technical Data

Wireless Call Buttons	included
Service Multiple Queues	up to 3
Unique Remote or Outlets	up to 99
LCD Flat Screen Display	included
Multiple Screen Size Options	yes
Up to 6 Video Interrupt Modes	included
Multiple Image/Video Formats	yes
Plays multimedia between queuing prompts	included
Dual-Voice & Multi-Language	included
Audio Alerts	included
Multiple Font & Colour Choices	yes
Customised Graphics	yes
Configuration Simulator	included

## Take control of your queues with our newest Electronic Queuing Management.

- >> Manage your customer flow and shorten wait times
- >> Utilise the value of promotion, advertising and branding

## Increase efficiency in customer service.

- >> With Qtrac™ dramatically improve the management of your customer flow
- >> The "Call Forward" system directs customers to the next available service point using digital voice and audio cues or arrows and text displayed on an LCD monitor
- >> Qtrac™ optimises customer throughput and increases service efficiency promoting customer satisfaction and loyalty

## Educate and inform your customers.

- >> Keeping customers engaged can reduce their perceived wait time by up to 50 percent
- >> Promotional stills or videos can play between queuing prompts
- >> Up to 6 different interrupt modes allow media to play full or split screen messages
- >> Use the built-in LCD display or connect to your own monitor
- >> Utilise multiple media formats: .bmp, .jpeg, .mpeg, .wmv

## Order Qtrac™ ready for use as is or customise to your own specifications.

- >> Qtrac™ is a powerful system that can be configured to your exact needs
- >> Choose audio alerts, multi-language voice-prompts, dual voices and custom text and images
- >> Customise fonts, background images, sound and text
- >> View your configured set-up in real time before going live



# Qtrac™ Electronic Queuing



## Qtrac's flexibility meets your changing needs.

- » Qtrac™ comes standard with advanced features
- » It can be configured from almost any PC and media can be quickly updated
- » Wireless technology makes it easy to add or move up to 99 station remotes
- » Wirelessly control numerous peripheral devices such as station lights or security doors



## Technical Data

### Qtrac™ CPU

Processor: Intel x86  
RAM: 196 Mb  
Hard Drive: 512 Mb  
USB Ports: 4  
Sound Card: Integrated  
Operating System: WinCE  
Video Output: VGA  
Monitor Size: 15", 19", and other sizes available  
Video Resolution: 800 x 600  
Sound Volume: 87 dB  
Power: 110V (US) or 220V (Europe)

### Qdrive™

Power: USB  
Memory: 4 Gb  
Frequency: 908.42 MHz (US) or 868.42 MHz (Europe)

### Station Remotes





Quantity per system: 5  
Range: 10 m indoors and 30 m outdoors  
Frequency: 908.42 MHz (US) or 868.42 MHz (Europe)  
Power: 4 AA batteries or AC adapter: 110V (US) or 220V (Europe)  
Queue Control Capacity: 3  
Available Functions: Next / Repeat / Unavailable



### Aluminium Sign Frames

- >> Available in vertical or horizontal standard format: DIN A4, DIN A3
- >> 8-way swivel frame is suitable for posts with 2,3 m belt lengths
- >> Fixed adapter available for posts with 3,7 m belt lengths

### Finishes:

- Chrome 
- Black 
- Satin 
- Brass 

### Tube Display

- >> Accommodates printed media/paper: DIN A4

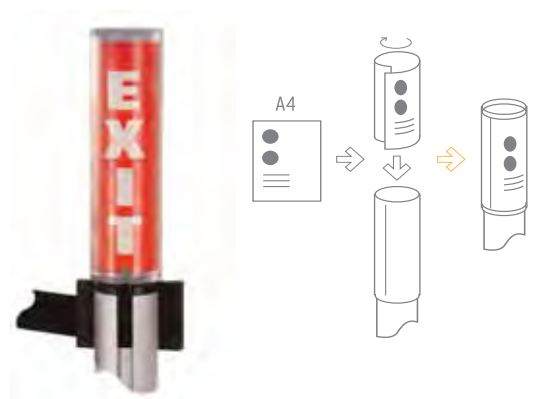

### Beltrac® - Sign Posts

- >> Post height of 2 m or 1,5 m
- >> Tube Diameter: approx. 70 mm
- >> Quick change aluminium frame with lateral attachment
- >> Finishes: Chrome, Satin, Black
- >> Base Diameter: approx. 490 mm
- >> Base Weight: approx. 17 kg
- >> Base Color: Black



**Wall Receptacle**

Aluminium belt receiver to be attached to the wall.

**Wall Receptacle (Breakaway Clip)**

A plastic safety clip to be attached to the wall. It is designed to release the belt under specific tension automatically.

**Safety Belt End**

The safety belt end is designed to automatically open if tension increases.

**Beltloc**

Beltloc prevents the unauthorized release of the belt.

Beltloc is available for all posts (excepting Outdoor). Please indicate the model of choice.



# Beltrac® Belt Imprinting



## Beltrac® - Customise the Belt Design

Customise your Beltrac® posts belts or Wall Mount belts with digital imprinting. From simple texts or logos to multi-colour photos, a wide range of printing variations are available thanks to our advanced imprinting techniques.

Our public guidance system can easily adapt to fit your company's needs. We can supply the belt with your company colours, with or without a logo, or with a short message to better inform your customers.

Use our posts or wall mounts with belt imprinted safety references to clearly direct your visitors away from closed off areas.

## Range of Applications

- >> Public guidance to check-in counters or waiting areas (Airline logos or other advertisement)
- >> Clear division for First, Business and Economy classes
- >> In front of the security check
- >> Entrance areas for arenas, cinemas, museums, retail stores, airports, etc.
- >> Baggage Claims
- >> VIP member reception
- >> Emergency exits
- >> Construction Zone partitioning
- >> And many more



**Nextrac® is a flexible merchandising system that utilises the Beltrac® Classic as its foundation. Incorporating the various merchandising components of the NeXtrac® system, allows you to graphically communicate to your customers while attractively offering retail products throughout the store or with impulse items in the check-out line. Nextrac® also enables the display of directional signage, advertising and corporate branding!**

- » Rigid rail system between posts (maximum length of 2 m, maximum height of 2 m)
- » Digitally imprinted banners can be hung between posts
- » The Nextrac® post and panel system enables the display of posters, logos or motifs
- » Our adjustable Banner Arm Assembly attaches vertically to any Beltrac Classic post to display your banner or flag.
- » Easy assembly / dismantling, flexible changeability of accessories, low maintenance





**Banner**

>> Eye-catching marketing promotions or advertisement



**Brochure Holder**

>> For brochure display



**Tray**

>> Ideal for clothing or brochures



**Post to Panel**

>> Narrow and QuickClip frames support a variety of marketing and promotional messages

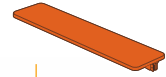

**Table**

>> Practical writing table



**Cross Bar**

>> Rigid rail barrier, straight or curved

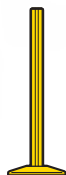

**Promotional Post**

>> Post without belt to accommodate banners or other signs  
>> Available with a height of 1 m, 1,5 m, or 2 m  
>> Finish: Black, Satin



**Merchandise Display Basket**

>> Standard baskets that offer a number of possibilities





**Merchandise Display Panel**

>> Works with the NeXtrac® merchandise display hook and basket



**Merchandise Display Hook**

>> Hooks available in different lengths for maximum adaptability



**Sign Frame**

>> Stationary or rotating quick change sign frames direct customers



**Rotating Merchandise Bowl**

>> A bowl attachment ideal for merchandise display on any post



**Grid Panel**

>> Transparent grid enhances advertising possibilities



**Digital Belt Imprinting**

>> Multi-colour graphics offer individual advertising possibilities



**Beltrac® Classic Post**

>> The basis for all NeXtrac® solutions

Our in-house team of experts will assist you in the designing and developing of NeXtrac® solutions that are uniquely tailored for your business and location. For more details please contact our sales department.

# Beltrac®

## Replacement parts

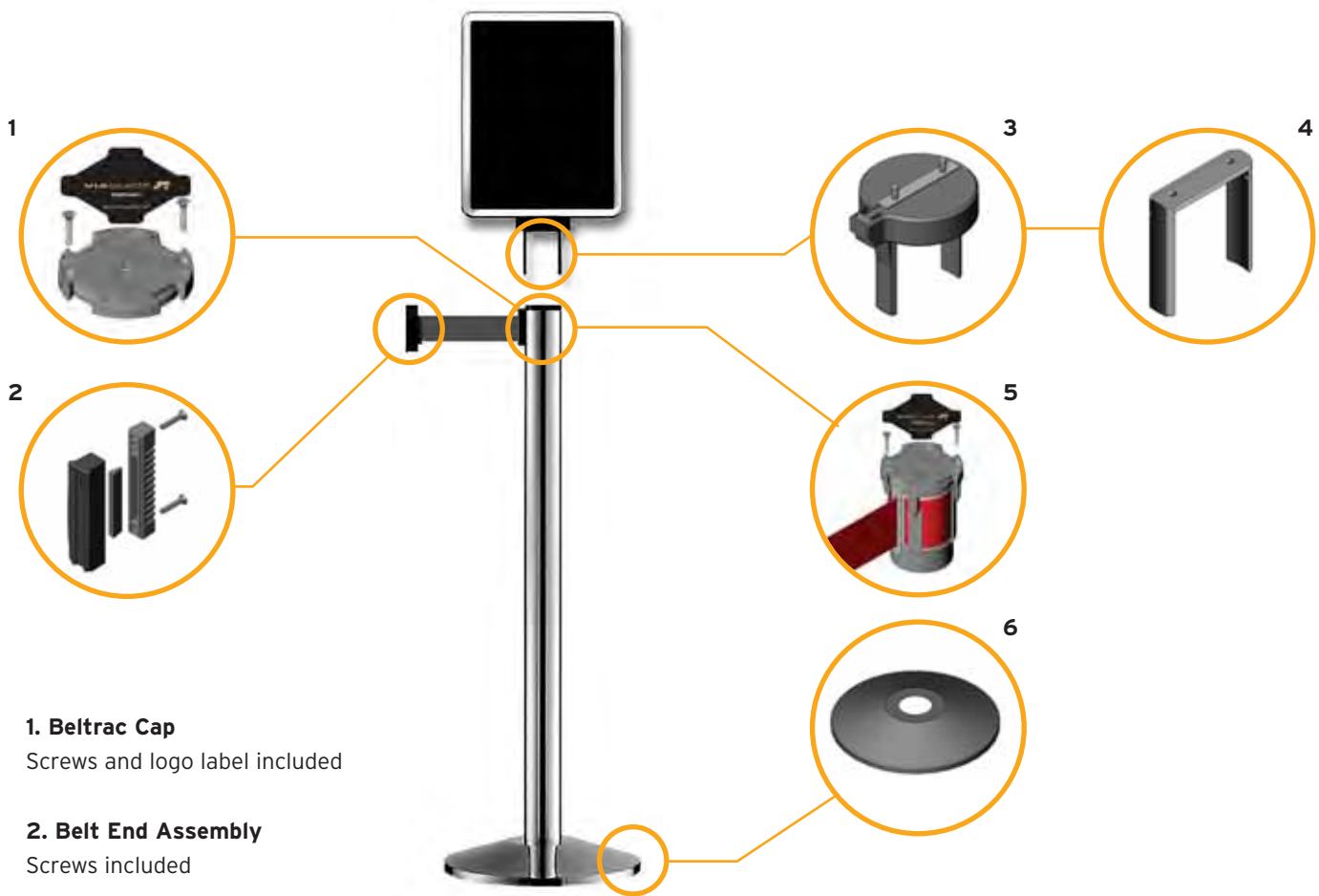

### 1. Beltrac Cap

Screws and logo label included

### 2. Belt End Assembly

Screws included

### 3. Metal Swivel Sign Bracket

Ideal with 2,3 m posts

### 4. Metal Fixed Mount Sign Bracket

Ideal with 2,3 m / 3,7 m belt posts

### 5. Replacement Mechanism

Screws and logo label included. For belt colors please visit Beltrac - the System chapter (pg. 6).

### 6. Cover Plate

For colors and finishes please see corresponding model descriptions.

## Via Guide Traditional - Exemplary Public Guidance in Elegant Form

It is important that the equipment used in the welcoming of visitors reflects the image of the organization. With Via Guide's high quality traditional public guidance system it is easy to create a superior impression on your patrons.

Select from a range of traditional models combined with ropes made from polypropylene or velvet. Please find more details on Via Guide's traditional post range in the following pages.

**MADE IN  
GERMANY**



# Traditional Luxor



## Luxor - Exemplary and Elegant

- >> Aesthetically rounded base
- >> Rope can be received from four different sides



Nickel  
Matte

Brass/  
Chrome

Brass

Chrome/  
Wood

Chrome



## Technical Data

	Total Weight	approx. 11 kg
	Base Weight	approx. 8 kg
	Signage	optional
	Outdoor Usage	no

## Mounting Options

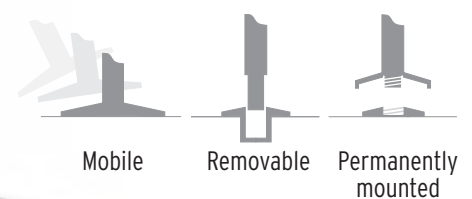

Mobile

Removable

Permanently  
mounted

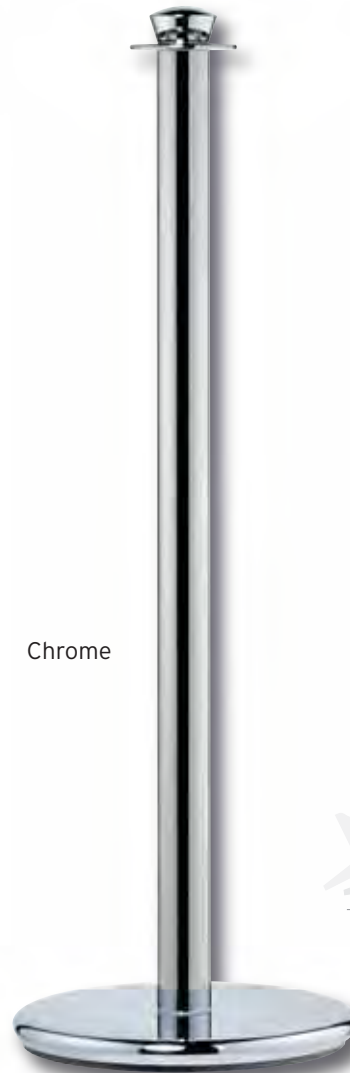



## Prado - Weather Resistant Post

- >> 3 standard finishes
- >> Outdoor option only available in a stainless steel finish with a polypropylene rope and stainless steel snap-end
- >> Round metal base cover plate
- >> Bottom base plate in black made of water resistant, resin based rubber



Nickel Matte

Chrome

Brass



Polished Stainless Steel



## Technical Data

	Total Weight	approx. 11 kg
	Base Weight	approx. 8 kg
	Signage	optional
	Outdoor Usage	optional

## Mounting Options

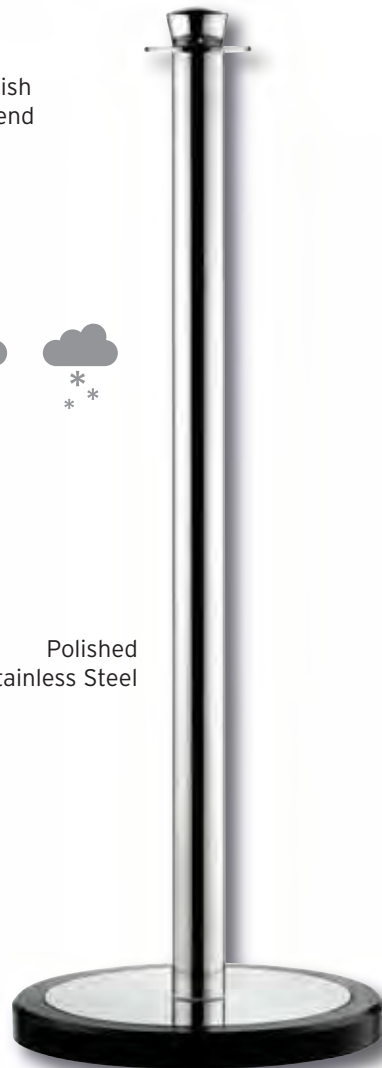
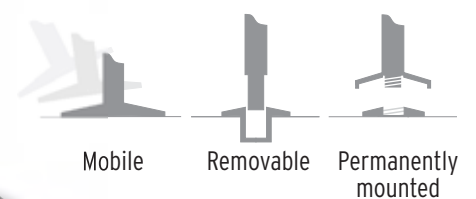

# Traditional Metropolis



## Metropolis - Progressive Line Management

- >> Formal, modern design
- >> Adaptable to many location styles



Chrome

Nickel  
Matte

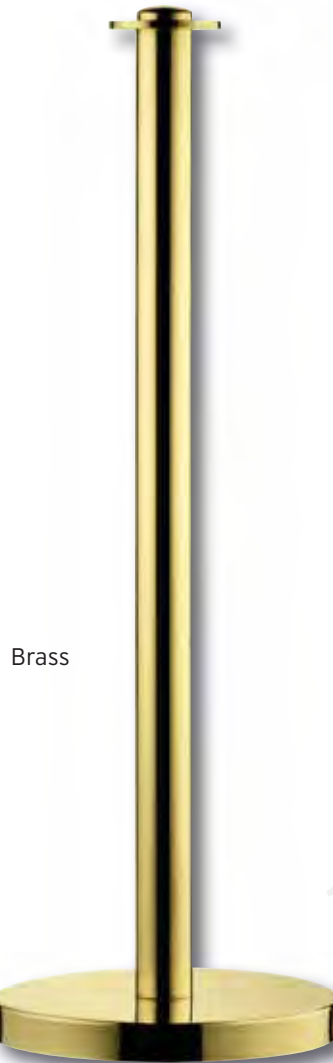

Brass



### Technical Data

	Total Weight	approx. 11 kg
	Base Weight	approx. 8 kg
	Signage	optional
	Outdoor Usage	no

### Mounting Options

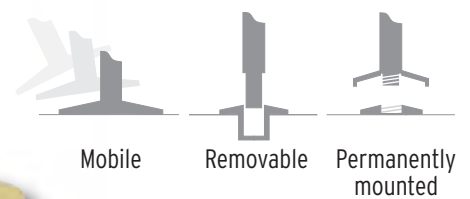

Mobile

Removable

Permanently  
mounted

# Traditional Ambassador



## Ambassador - Clear Design Form

- >> Polished Nickel finish
- >> Upscale public guidance system

### Technical Data

	Total Weight	approx. 11 kg
	Base Weight	approx. 8 kg
	Signage	optional
	Outdoor Usage	no

Polished Nickel



### Mounting Options

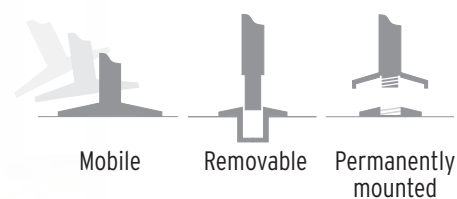

# Traditional Crown



## Crown - Timeless Elegance

- >> Noble globe head
- >> High functionality



Chrome

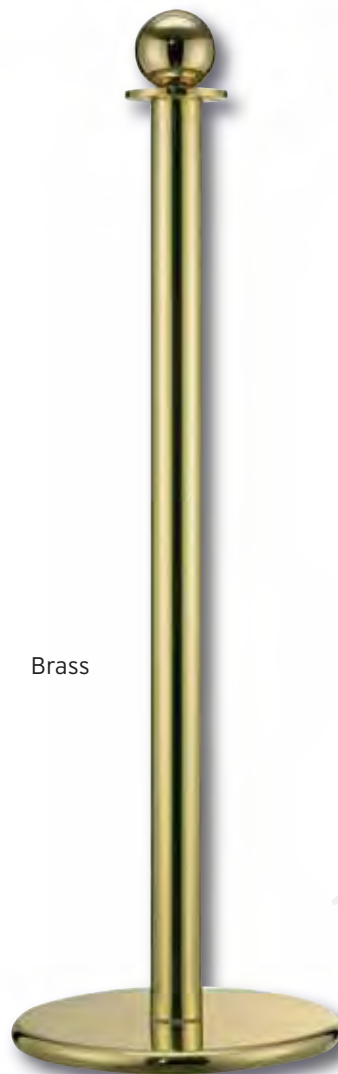

Brass



## Technical Data

	Total Weight	approx. 11 kg
	Base Weight	approx. 8 kg
	Signage	no
	Outdoor Usage	no

## Mounting Options

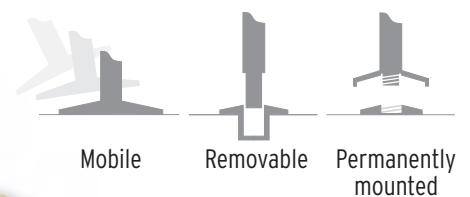





## Museum - The Exhibit Solution

- >> Low overall height
- >> Offers unobstructed viewing of sculptures, paintings or other exhibits

## Accessories

Round Rope End



Flat Rope End



Wall Mount



## Technical Data

	Total Weight	approx. 9,5 kg
	Base Weight	approx. 8 kg
	Signage	no
	Outdoor Usage	no

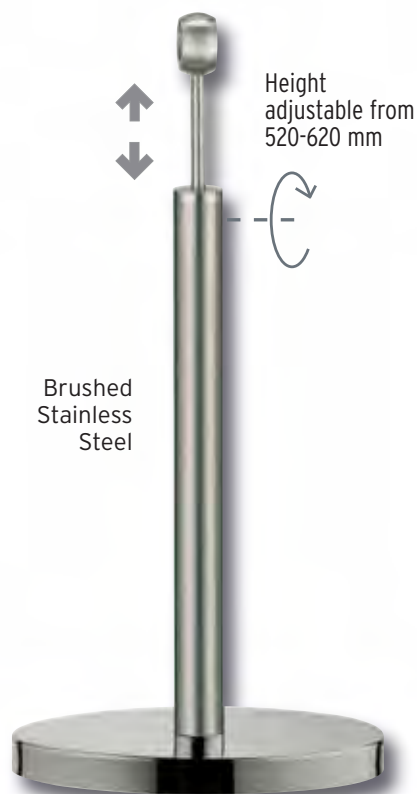

## Mounting Options



Mobile



Permanently mounted

# Traditional Ropes

## Material

- >> Velvet or natural looking, weather resistant polypropylene
- >> Each rope includes 2 snap-ends
- >> Wide range of rope colours

## Snap-Ends

Connection between rope and post.



Chrome    Brass    Satin    Brushed Stainless Steel

## Functionality

For quick attachment and detachment, the rope ends are equipped with snap-ends.

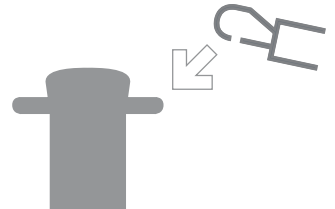

## Wall Receptacle

The practical solution for the attachment of ropes between the post and the wall or between two walls. Dimensions: 30 x 30 mm.



Chrome    Brass    Satin

## Polypropylene Rope\*



Red    Green    Blue    Beige    Brown    Black    Jute-Look

## Velvet Rope\*



Red    Blue    Brown    Black

! \* Typographically caused color variations possible.

## Aluminium Sign Frame

Aluminium sign frames are an ideal supplement to traditional posts as they effectively display information or messages.

### Available as follows:

A4 vertical format / A4 horizontal format  
A3 vertical format / A3 horizontal format

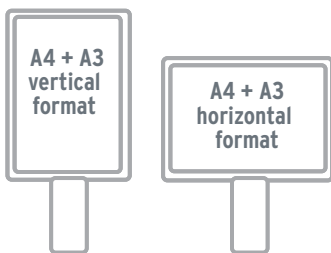

Chrome



Brass



Satin

## Acrylic Frames

Possibility to fit to Luxor, Prado, Metropolis and Ambassador posts. It can be integrated into a guidance system and allows for the easy insertion and exchange of signs and messages.

### Available as follows:

A4 vertical format  
A3 vertical format



Chrome or Brass

## Posts with Frames

Luxor post is also available with a direct frame connection without the head ring.

### Available as follows:

A4 vertical format / A4 horizontal format  
A3 vertical format / A3 horizontal format

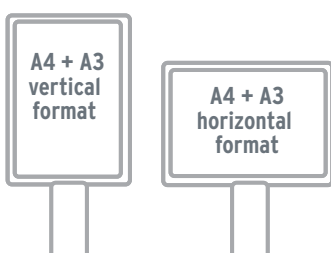

Brass

Chrome



Chrome

Satin



# VIAGUIDE

Via Guide GmbH  
Rönkhauser Straße 9  
D-59757 Arnsberg-Müschede

Phone +49(0)2932 / 477 - 177  
Fax +49(0)2932 / 477 - 7177  
info@viaguide.de  
[www.viaguide.de](http://www.viaguide.de)